

PRODUCT SHORT DESCRIPTION:

Space saving multi surface dry erase boards

FEATURES AND BENEFITS:

- Essential Topaz Series:
 - Good value for money for frequent use
- Essential Sapphire Series:
 - Good value for money, ideal for audiovisual and educational use
- Three times the surface area
- Hide confidential or pre-prepared material
- Optional cork notice board on front faces
- Available in three choices of surface
 - Melamine
 - Lacquered steel
 - Enamel
- Pen tray and wall fixings supplied

PRODUCT IMAGE:



MARKETING COPY:

Expand your presentation with our Trios. Bi-Office Trio collection has EN14434 certified products and can be purchased in lacquered steel, enamel or even cork surfaces. The Trios are closed cabinet boards that can be opened when needed to enlarge the writing or pin area or even hide pre-prepared contents.

APPLICATION AND SALES PROPOSITION:

- Versatile presentation support
- Easy to expand to a larger presentation area

TARGET MARKET:

CHANNEL: Office products wholesalers, office products stores, decoration products wholesalers, decoration stores and other retailers
 END USERS: conference centers, hotels, companies and organizations in general

ADDITIONAL NOTES:

Other information supports: our official websites, Youtube®, Facebook®, catalogue and online catalogue, demo videos and more.

PROMOTIONAL TIPS:

No specific timing, thus we recommend the occasional promotion like product and offering of cleaning kits or markers

RANGING TABLE:

Frame/Colour:	Surface/Colour:	Product Size:	Packed mm	N.W. kg	G.W. kg	Reference:	RRP:
ESSENTIAL TOPAZ SERIES							
Aluminium	Enamel	1800x600	1030x620x50	9,43	10,27	TR01030207170	---
Aluminium	Enamel	2400x900	1330x920x50	18,87	20,52	TR02030207170	---
Aluminium	Melamine	1800x600	1030x620x50	7,90	9,00	TR01010302170	---
Aluminium	Melamine	2400x900	1330x920x50	15,10	16,75	TR02010302170	---
Aluminium	Lacquered steel	1800x600	1030x620x50	7,63	8,47	TR01020509170	---
Aluminium	Lacquered steel	2400x900	1330x920x50	15,10	16,75	TR02020509170	---
Aluminium	Lacquered Steel / Cork	1800x600	1030x620x50			TR01020101170	---
Aluminium	Lacquered Steel / Cork	2400x900	1330x920x50			TR02020101170	---

Frame/Colour:	Surface/Colour:	Product Size:	Packed mm	N.W. kg	G.W. kg	Reference:	RRP:
ESSENTIAL SAPPHIRE SERIES							
Aluminium	Enamel	3000x1000				TR03030207170	---
Aluminium	Enamel	3600x1200				TR09030207170	---
Aluminium	Enamel	4000x1000	2200x1050x50	33,48	36,84	TR05030207170	---
Aluminium	Lacquered steel	3000x1000				TR03020509170	---
Aluminium	Lacquered steel	3600x1200				TR09020509170	---
Aluminium	Lacquered steel	4000x1000	2200x1050x50	27,32	30,68	TR05020509170	---
Aluminium	Melamine	3000x1000				TR03010302170	---
Aluminium	Melamine	3600x1200				TR09010302170	---
Aluminium	Melamine	4000x1000	2200x1050x50	27,50	30,70	TR05010302170	---
Aluminium	Lacquered Steel / Cork	3000x1000				TR03020101170	---
Aluminium	Lacquered Steel / Cork	3600x1200				TR09020101170	---
Aluminium	Lacquered Steel / Cork	4000x1000				TR05020101170	---

TECHNICAL DETAILS**COMPOSITION:**

- Aluminum frame
- Wooden based core with enamel, lacquered steel or melamine surface on chipboard
- melamine surface: 5 year warranty
- lacquered steel surface: 10 year warranty
- enamel surface: 25 year warranty

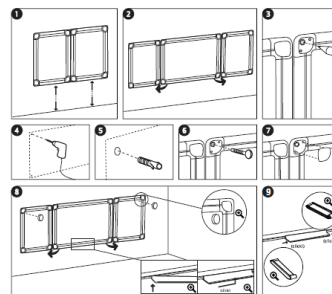
ASSEMBLY OVERVIEW:**CERTIFICATION AND LEGISLATION:**

n/a

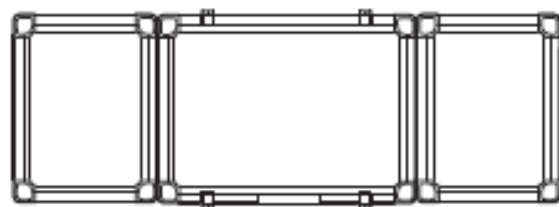
ILLUSTRATION:

SUGGESTED ADVERT:**Maya Trio Whiteboards - Essential Series****Space saving multi surface dry erase boards**

- Essential Topaz Series:
 - Good value for money for frequent use
- Essential Sapphire Series:
 - Good value for money, ideal for audiovisual and educational use
- Three times the surface area
- Hide confidential or pre-prepared material
- Optional cork notice board on front faces
- Available in three choices of surface
 - Melamine
 - Lacquered steel
 - Enamel
 - Lacquered steel / cork
- Pen tray and wall fixings supplied

**WITHIN FAMILY:**

- Maya Whiteboards
- New Generation Whiteboard
- Eclipse Whiteboard
- Provision Whiteboard
- Mastervision Whiteboard

QR CODE:**Author:** Sandra Faria**Approval:**
Revision: 02
Date: 9-05-2017

TRIO MAYA

INSTRUCTIONS • INSTRUCTIES • ISTRUZIONI • ANLEITUNG • INSTRUCCIONES • INSTRUÇÕES

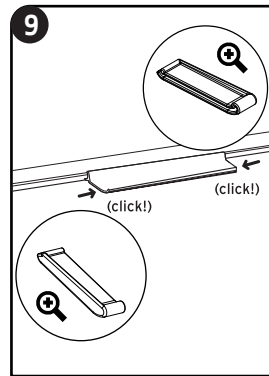
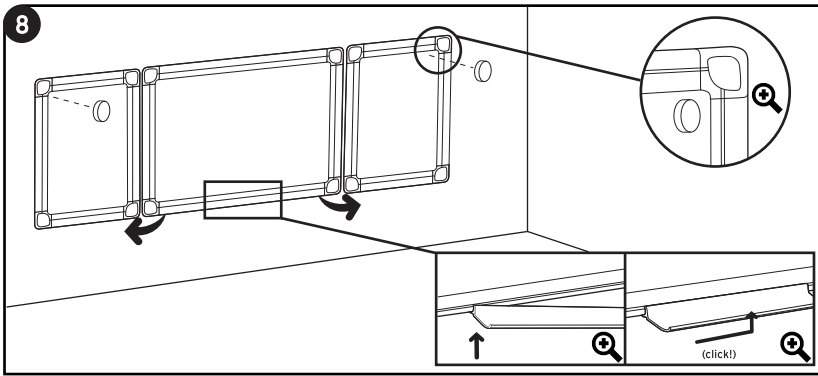
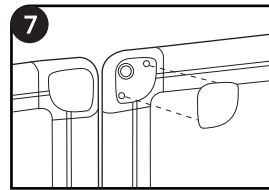
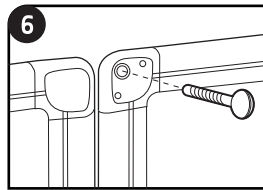
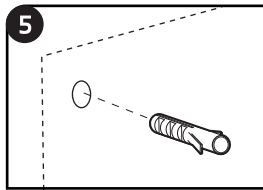
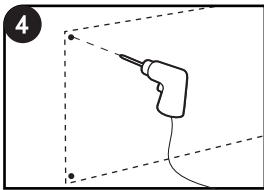
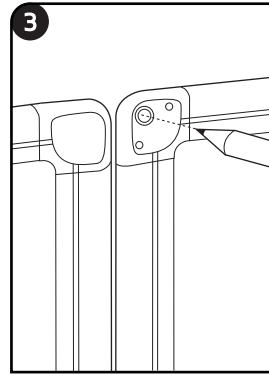
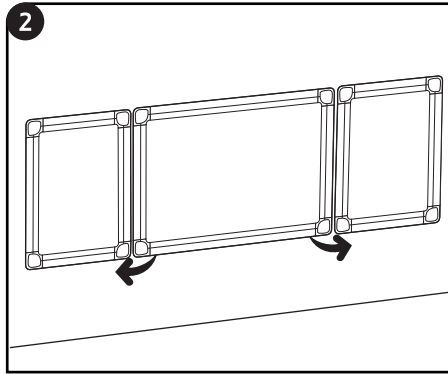
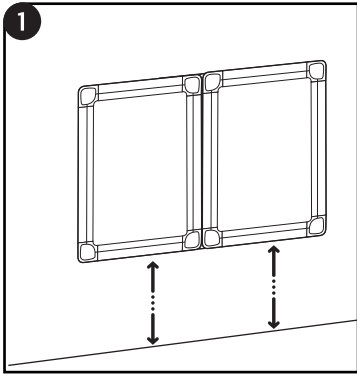

≥ 150cm/59"

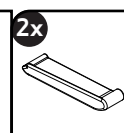
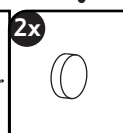
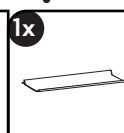
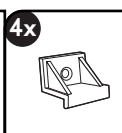
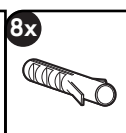
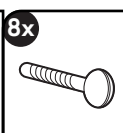
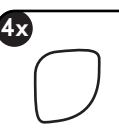
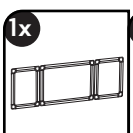
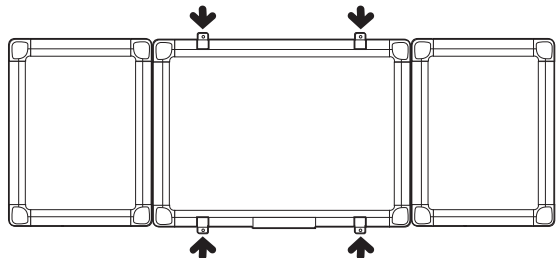
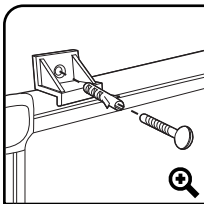

38010348